

MOOD mood collection / collection mood

Un sistema di pareti divisorie in vetro autoportante in cui ogni elemento presenta minimo ingombro visivo e massima resistenza meccanica. Un progetto ispirato a criteri di eco compatibilità che prevede l'impiego di materiali perfettamente riciclabili e ricorre a tecniche produttive a forte sostenibilità ambientale.

A system of free-standing glass partitions where every element presents minimum visual encumbrance and maximum mechanical resistance. The project is inspired by eco-compatibility criteria that call for the use of perfectly recyclable materials and uses environmentally sustainable manufacturing techniques.

Un système de cloisons de séparation en verre autoportant dont chaque élément présente un minimum d'encombrement visuel pour un maximum de résistance mécanique. Un projet inspiré par des critères d'écocompatibilité prévoyant l'utilisation de matériaux parfaitement recyclables et exploitant les techniques de production à durabilité environnementale.

M | 1

M | 2

M | M

M | N

PARETE ECOSOSTENIBILE ecological wall/ cloison fabriquée avec des écomatériaux **PROFILI DI DIMENSIONI RIDOTTE** reduced dimensions / profils de dimensions réduites **GUARNIZIONI RICICLABILI** recyclable seals / joints recyclables **VETRI 10/11 O 12/13 SENZA CAMBIARE PROFILO FERMAVETRO** 10/11 or 12/13 glass without changing glazing bead profile / vitres 10/11 ou 12/13 sans changer la parclose **PANNELLI IN LEGNO AD AGGANCIAMENTO REVERSIBILE SU VETRO** wooden panels with reversible attachment on glass / panneaux en bois à accrochage réversible sur vitre **ELEVATO ABBATTIMENTO ACUSTICO** substantial sound proofing / isolation acoustique élevée **FACILITÀ DI MONTAGGIO** easy fitting / facilité de montage **4 TIPI DI ANTE COMUNI A TUTTE LE COLLEZIONI** 4 types of doors shared with all collections / 4 types de porte communs entre toutes les collections **PARASPIFFERI PER ANTE IN LEGNO E DOPPIO VETRO** draft extractor for wooden and double glazed doors / bas de porte pour portes en bois et double vitrage

CERNIERA A SCOMPARSA concealed hinges / charnière escamotable **TELAIO PORTA CABLABILE** wiring friendly door frame / châssis de porte pouvant être câblé **SERRATURA SU MONTANTE PORTA** locks on door upright / serrure sur montant de la porte **MOLLA CHIUDIPISTA INCASSATA AL TRAVERSO SUPERIORE DEL TELAIO PORTA** door close spring recessed into upper door frame crosspiece / ferme-porte à ressort encastré dans la traverse supérieure du châssis de la porte **PORTE SCORREVOLI CON GUIDA INTEGRATA NEL PROFILO FERMAVETRO** sliding doors with guide rails integrated in the glazing bead / portes coulissantes avec rail intégré dans la parclose **MANIGLIA LINEARE ORIZZONTALE** linear horizontal handle / poignée linéaire horizontale **MANIGLIONI IN VARIE ALTEZZE PER PORTE A BATTENTE O SCORREVOLI** handles at various heights for slam or sliding doors / poignées à plusieurs hauteurs pour portes battantes ou coulissantes



M | 1

Parete divisoria mono vetro che accoglie lastre autoportanti da 10/11 o 12/13 mm. Il profilo fermavetro da 40 mm consente un'ottimale regolazione in fase di livellamento, pur mantenendo un impatto visivo estremamente contenuto. Le connessioni verticali, tra moduli vetrati, sono realizzate in profili di metacrilato o alluminio.

Single panel partition that accommodates 10/11 or 12/13 mm free-standing sheets. The 40 mm glazing bead profile allows excellent adjustment during levelling while maintaining an extremely contained visual impact. The vertical connections between glass modules are made of methacrylate or aluminium profiles.

Cloison de séparation mono-vitre accueillant des plaques autoportantes de 10/11 ou 12/13 mm. Le profil parelose de 40 mm permet un réglage optimal en phase de nivellement tout en maintenant un impact visuel extrêmement contenu. Les raccords verticaux entre les modules vitrés sont réalisés en profilés de méthacrylate ou d'aluminium.

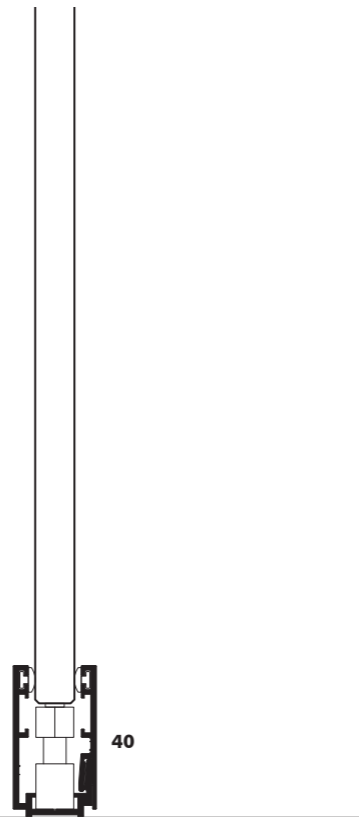



M 2

Parete doppio vetro che accoglie lastre autoportanti da 10/11 o 12/13 mm, studiata per ottenere elevate prestazioni di abbattimento acustico, mantenendo uno spessore di soli 50 mm. Si integra perfettamente con le altre versioni di Mood impiegandone tutti gli accessori, connessioni tra moduli vetrati e porte a battente e scorrevoli.

Double panel partition that accommodates 10/11 or 12/13 mm free-standing sheets, designed for increased sound reducing performance while maintaining a thickness of only 50 mm. It integrates perfectly with the other Mood versions, using all of the accessories, connections between the glass modules, and swinging and sliding doors.

Cloison double-vitrage accueillant les plaques autoportantes de 10/11 ou 12/13 mm, conçue pour obtenir des performances élevées en matière de réduction des bruits en maintenant une épaisseur de 50 mm seulement. Elle s'adapte parfaitement aux autres versions de Mood en exploitant tous les accessoires, les raccords entre les modules vitrés et les portes à vantail et coulissantes.

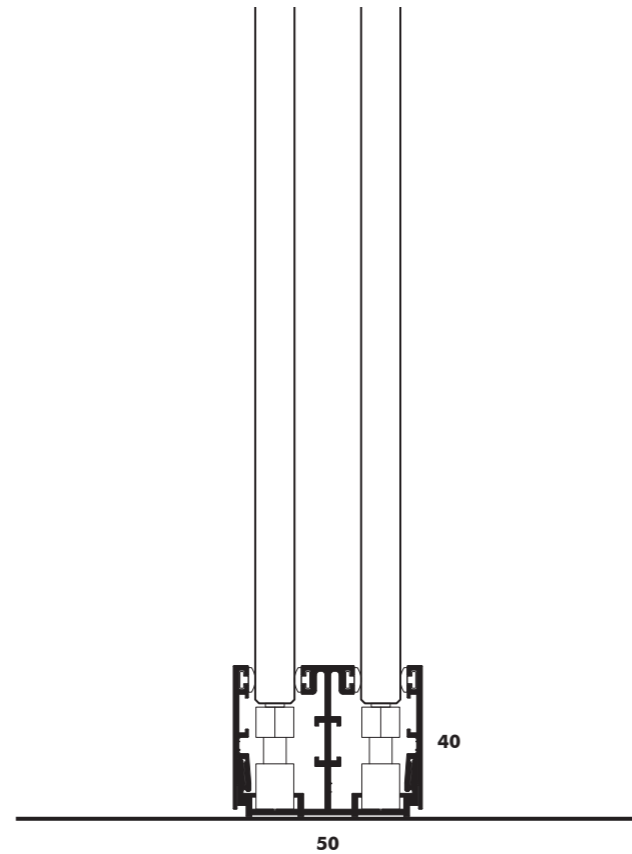



M | M

Una parete divisoria mono vetro autoportante da 10/11 o 12/13 mm nata con l'obiettivo di minimizzare l'impatto visivo dei profili fermavetro di base e sommitali. Si integra perfettamente con le altre versioni di Mood impiegandone tutti gli accessori, connessioni tra moduli vetrati e porte a battente e scorrevoli.

A single panel free-standing partition, 10/11 or 12/13 mm, created with the goal of minimizing the visual impact of the glazing bead profiles on the base and top. It integrates perfectly with the other Mood versions, using all of the accessories, connections between the glass modules, and swinging and sliding doors.

Une cloison de séparation mono-vitre autoportante de 10/11 ou 12/13 mm née dans le but de minimiser l'impact visuel des profils pareclose inférieur et supérieur. Elle s'adapte parfaitement aux autres versions de Mood en exploitant tous les accessoires, les raccords entre les modules vitrés et les portes à vantail et coulissantes.

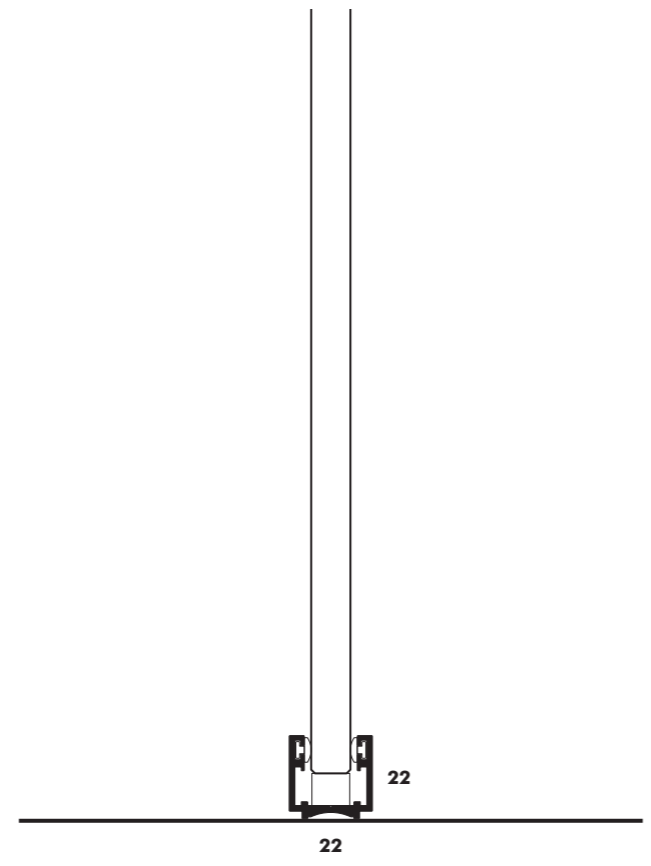



M | N

Una parete divisoria in cui i profili fermavetro sono completamente incassati nel pavimento, a soffitto e nelle pareti d'ambito. Una soluzione di grande rigore formale e impegno progettuale che massimizza l'impiego del vetro mettendo in risalto accessori e porte che campeggiano in setti fatti di trasparenza.

A partition in which the glazing bead profiles are completely built into the floor, ceiling, and walls of the room. It is a highly precise solution with a design effort that maximizes the use of glass while highlighting the accessories and doors that stand in transparent panels.

Une cloison de séparation dont les profils parcloise sont complètement encastrés dans le sol, au plafond et dans les murs de la pièce. Une solution à grande rigueur formelle et application conceptuelle qui optimise l'utilisation du verre en faisant ressortir les accessoires et les portes insérées dans des cloisons transparentes.

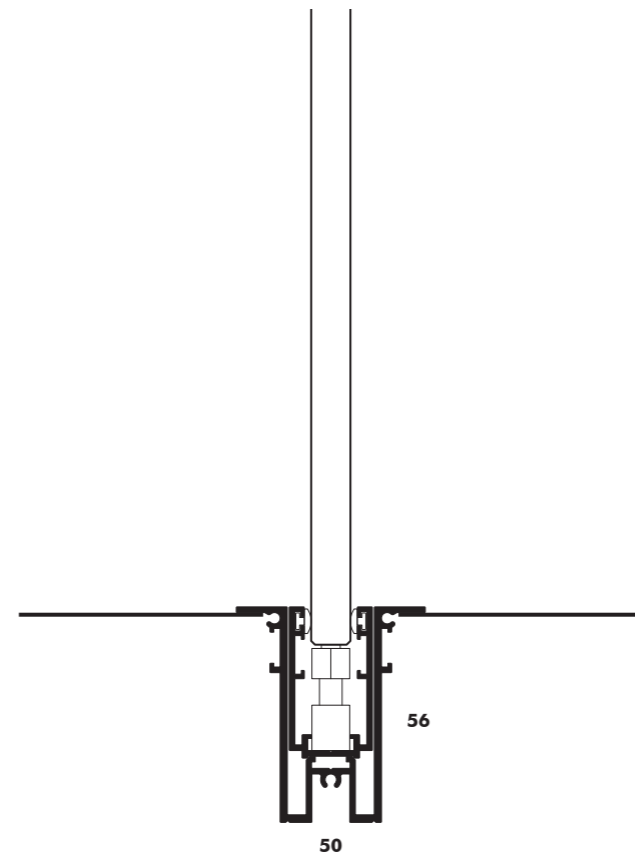



MOOD FREESTANDING

Box autoportanti per allestimenti innovativi e flessibili. Spazi di lavoro confinati o aree di concentrazione in cui il vetro è impiegato come elemento strutturale completamente svincolato dalla scatola architettonica.

Free-standing cubicle for innovative and flexible outfitting. Confined work areas or concentration areas where glass is used as a structural element that is completely released from the architectural box.

Cabines autoportantes pour agencements innovants et flexibles. Espaces de travail confinés ou bien aires de concentration où le verre est utilisé comme élément structurel complètement libéré de la structure architectonique.



Stile, leggerezza, equilibrio delle proporzioni. Porte incastonate nel vetro, maniglioni dal design esclusivo, molteplici finiture di vetro, alluminio e legno. Particolari per creare ambienti di lavoro accoglienti e stimolanti.

Style, lightness, balance of proportions. Doors set in the glass, uniquely designed handles, and numerous glass, aluminium, and wood finishes. Details to create inviting and stimulating work areas.

Style, légèreté, équilibre des proportions. Portes enchâssées dans le verre, poignées au design exclusif, nombreuses finitions de verre, aluminium et bois. Détails pour créer des pièces de travail accueillantes et stimulantes.





Pannelli in legno da fissare liberamente alle partizioni in vetro. Fissaggi in velcro tecnico che permettono ancoraggi facili e reversibili ideali per creare infinite composizioni, strettamente funzionali o puramente formali.

Wood panels that can be freely attached to the glass partitions. Velcro attachment that allow easy and reversible anchoring, ideal for creating an infinite number of compositions, strictly functional or purely formal.

Panneaux en bois à fixer librement aux partitions en verre. Fixations en velcro technique permettant des ancrages faciles et réversibles pour créer une infinité de compositions, strictement fonctionnelles ou purement formelles.



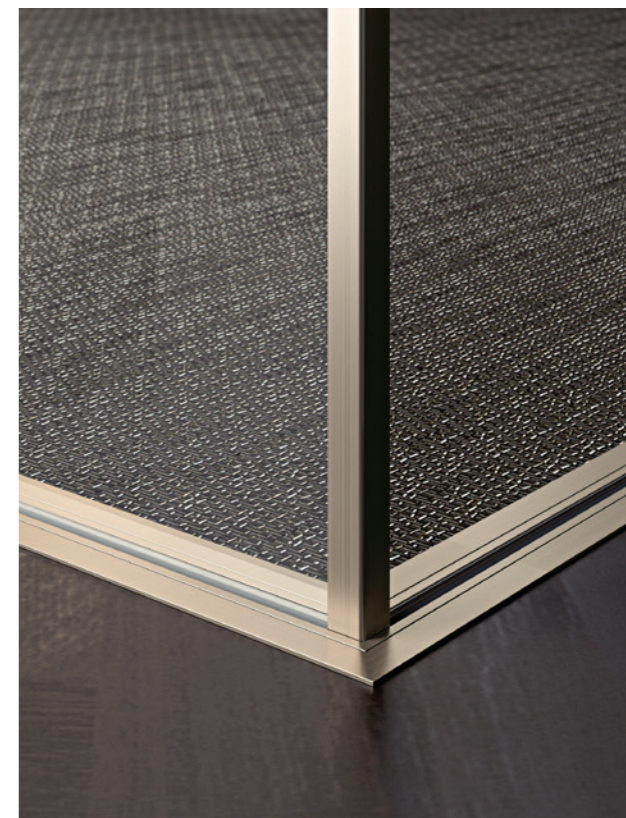

Partenze da parete, connessioni lineari o d'angolo studiate per configurazioni flessibili e funzionali. Ogni elemento è dimensionato per consentire un'ottimale allineamento tra elementi vetrati e profili in alluminio.

Departures from the wall, linear or corner connections designed for flexible and functional configurations. Each element is sized to allow excellent alignment between glass elements and aluminium profiles.

Appuis muraux, raccords linéaires ou angulaires étudiés pour des configurations flexibles et fonctionnelles. Chaque élément est dimensionné pour permettre un alignement optimal entre les éléments vitrés et les profils d'aluminium.

Elementi vetrati che si innestano nei contenitori. Divisione e contenimento per soddisfare, contemporaneamente, esigenze distributive e operative, integrandole. Connessioni perfette senza soluzione di continuità.

Glass elements that can be inserted in the containers. Division and containment to simultaneously satisfy distributive and operative needs, integrating them. Perfect connections without continuity solutions.

Éléments vitrés qui s'enclenchent aux armoires. Séparation et espace contenu pour satisfaire simultanément les exigences distributives et fonctionnelles en les complétant. Raccords parfaits sans solution de continuité.



Profili fermavetro incassati nei fianchi e nei top di pareti contenitore in varie altezze, per garantire pulizia formale e chiarezza di connessione. Soluzioni tecniche semplici dettate da grande gusto e profonda esperienza.

Glazing bead profiles built into the sides and top of the container walls of various heights to ensure clean lines and clear connections. Simple technical solutions dictated by taste and experience.

Profils parcloze encastrés dans les flancs et dans la partie supérieure de l'armoire de différentes hauteurs afin de garantir netteté formelle et raccordement simple. Des solutions techniques simples et dictées par le goût et l'expérience.



ANTA IN VETRO SINGOLO

glass door / porte en verre

Porta con anta in vetro temperato dotata di cerniera lineare in estruso di alluminio a completa scomparsa dietro alla battuta del telaio porta. Maniglie e maniglioni in alluminio con serratura integrata o sul montante.

Swinging door with slim frame and single, stratified glass, linear hinge, spring door closer inserted in the upper crosspiece of the jamb. Handles and pull handles in aluminium with lock built-in or on the upright.

Porte à petit châssis et verre feuilleté, charnière linéaire, ressort ferme-porte encastré dans la traverse supérieure de l'intrados. Petites et grosses poignées en aluminium à serrure intégrée ou sur le montant.

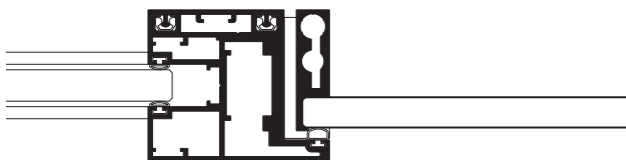

ANTA INTELAIATA MONOVETRO

single panel door in the frame / porte mono-vitre fixée sur le châssis

Porta ad anta con telaio sottile e vetro singolo stratificato, cerniera lineare, molla chiudiporta incassata nel traverso superiore dell'imbotte. Maniglie e maniglioni in alluminio con serratura integrata o sul montante.

Swinging door with slim frame and single, stratified glass, linear hinge, spring door closer inserted in the upper crosspiece of the jamb. Handles and pull handles in aluminium with lock built-in or on the upright.

Porte à petit châssis et verre feuilleté, charnière linéaire, ressort ferme-porte encastré dans la traverse supérieure de l'intrados. Petites et grosses poignées en aluminium à serrure intégrée ou sur le montant.

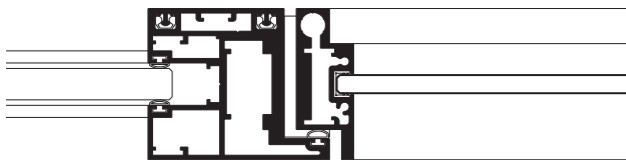

ANTA INTELAIATA DOPPIO VETRO

double panel door in the frame / porte double-vitrage fixée sur le châssis

Porta ad anta intelaiata a doppio vetro, cerniera lineare, chiudiporta completamente incassato nel traverso superiore dell'imbotte, para spifferi. Maniglie e maniglioni in alluminio con serratura integrata o sul montante.

Double panel door in the frame, linear hinge, door closer completely built into the upper crosspiece of the jamb, draught excluder. Handles and pull handles in aluminium with lock built-in or on the upright.

Porte à double-vitrage fixée sur le châssis, charnière linéaire, ferme-porte complètement encastré dans le linteau supérieur de l'intrados, bas de porte. Petites et grosses poignées en aluminium à serrure intégrée ou sur le montant.

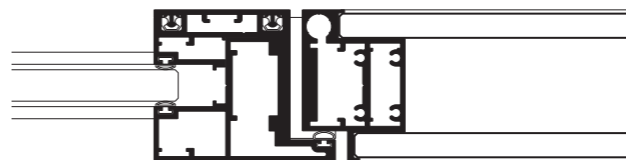

ANTA INTELAIATA LEGNO

wood door in frame / porte en bois fixée sur le châssis

Porta con anta in legno nobilitato e telaio in alluminio, cerniera lineare, chiudiporta incassato nel traverso superiore dell'imbotte, para spifferi. Maniglie e maniglioni in alluminio con serratura integrata o sul montante.

Laminated door and aluminium frame, linear hinge, door closer completely built into the upper crosspiece of the jamb, draught excluder. Handles and pull handles in aluminium with lock built-in or on the upright.

Porte en bois ennoblé et châssis en aluminium, charnière linéaire, ferme-porte encastré dans le linteau supérieur de l'intrados, bas de porte. Petites et grosses poignées en aluminium à serrure intégrée ou sur le montant.

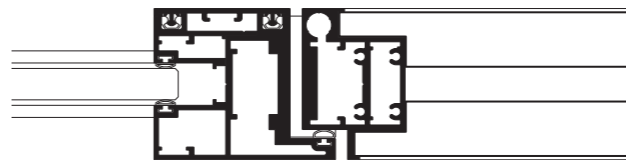

Porte a doppia anta, in vetro o legno, ampie e funzionali proposte in altezze standard o di vano. Profilo centrale di battuta in estruso di alluminio con guarnizioni di sigillatura per garantire una perfetta tenuta acustica.

Double door in glass or wood, wide and functional and offered in standard heights or in the door frame. Central rail stop in extruded aluminium with gaskets to ensure a perfect acoustic seal.

Porte à double battant, en verre ou en bois, amples et fonctionnelles proposées en hauteurs standard ou sur mesure. Profilé central de butée en aluminium extrudé avec joints de scellage pour garantir une isolation sonore parfaite.



Porte a doppia anta, in vetro o legno, caratterizzate da sopra luce vetrati. Una soluzione progettuale di grande leggerezza formale e stabilità meccanica, un modo alternativo di proporre i punti di passaggio.

Double door in glass or wood with glass transom. A design solution with great formal lightness and mechanical stability, an alternate method of offering passage ways.

Porte à double battant, en verre ou en bois, caractérisées par des impostes vitrées. Une solution conceptuelle de grande légèreté formelle et stabilité mécanique, une autre façon de proposer les points de passage.



Porte scorrevoli in vetro o in legno ad anta singola o doppia. La guida di scorrimento è perfettamente integrata con il profilo di alloggiamento del vetro. Fermo ammortizzato per garantire comfort e sicurezza.

Sliding glass or wood single or double doors. The sliding guide is perfectly built into the profile that holds the glass. Cushioned stop to ensure comfort and safety.

Portes coulissantes en verre ou en bois à battant simple ou double. Le rail de guidage est parfaitement intégré avec le profilé de logement de la vitre. Arrêteur tampon pour garantir confort et sécurité.



ANTA IN VETRO SINGOLO

glass door / porte en verre

Porta scorrevole con anta in vetro temperato, singola o doppia. Guida di scorrimento integrata con il profilo fermavetro e meccanismo di fermo ammortizzato in chiusura e apertura. Maniglioni verticali con e senza serratura.

Sliding door with tempered glass panel, single or double. Built-in sliding guide with glazing bead profile and cushioned stop mechanism when opening and closing. Vertical handles with and without lock.

Porte coulissante en verre trempé à simple ou double battant. Rail de guidage intégré avec le profil parcloze et mécanisme d'arrêt tampon en fermeture et ouverture. Grosses poignées verticales avec et sans serrure.

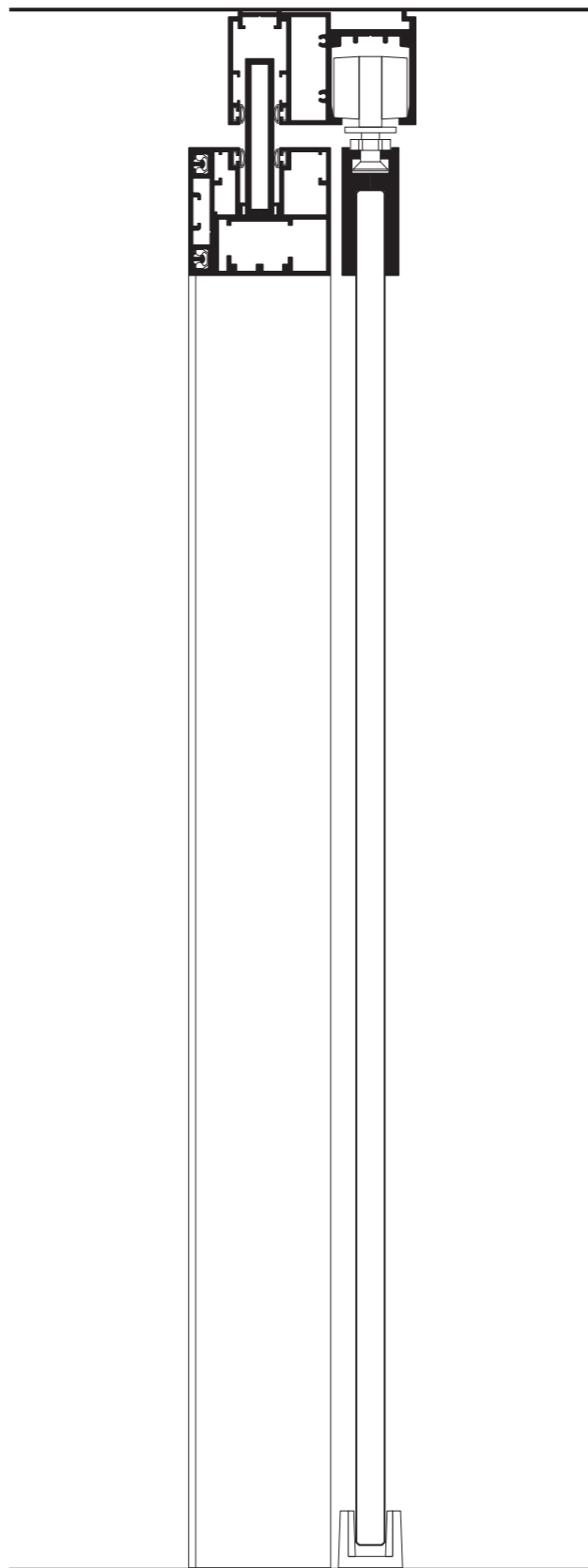

ANTA INTELAIATA MONOVETRO

single panel door in the frame / porte mono-vitre fixée sur le châssis

Porta scorrevole con anta, singola o doppia, in vetro con telaio in alluminio. Guida di scorrimento integrata con il profilo fermavetro e fermo ammortizzato in chiusura e apertura. Maniglioni verticali con e senza serratura.

Sliding door with single or double glass panel and aluminium frame. Built-in sliding guide with glazing bead profile and cushioned stop when opening and closing. Vertical handles with and without lock.

Porte coulissante à un ou double battant, en verre avec châssis en aluminium. Rail de guidage intégré avec le profil parcloze et arrêtoir tampon en fermeture et ouverture. Grosses poignées verticales avec et sans serrure.

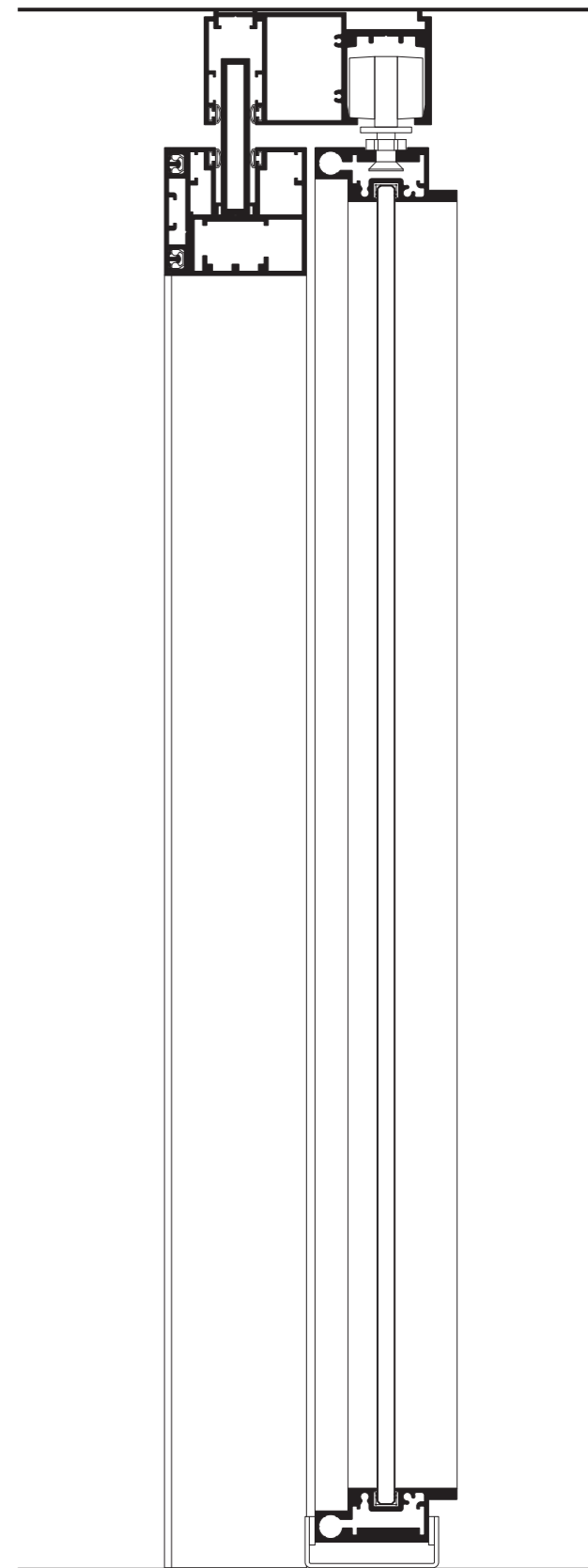

ANTA INTELAIATA DOPPIO VETRO

double panel door in the frame / porte double-vitrage fixée sur le châssis

Porta scorrevole con anta intelaiata doppio vetro, singola o doppia. Guida di scorrimento integrata con il profilo fermavetro e fermo ammortizzato in chiusura e apertura. Maniglioni verticali con e senza serratura.

Sliding door with double panel in frame, single or double Built-in sliding guide with glazing bead profile and cushioned stop when opening and closing. Vertical handles with and without lock.

Porte coulissante fixée sur le châssis en verre trempé à simple ou double vitrage. Rail de guidage intégré avec le profil parcloise et arrêteur tampon en fermeture et ouverture. Grosses poignées verticales avec et sans serrure.

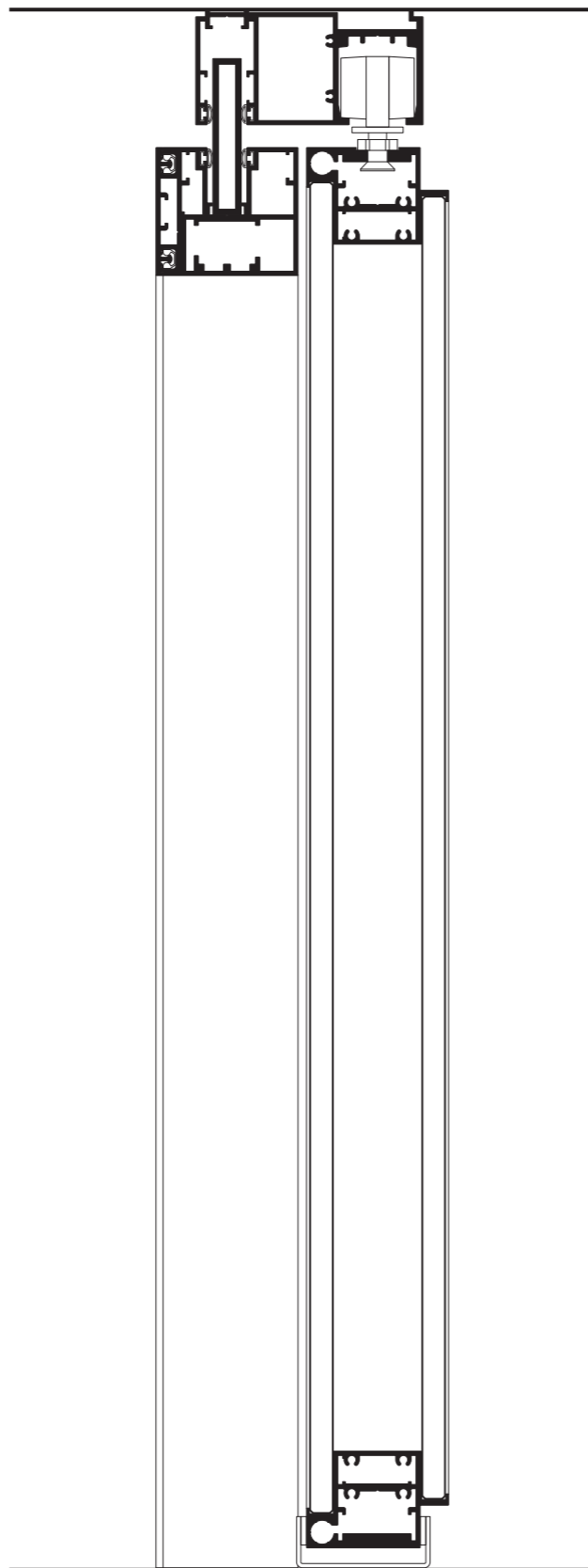

ANTA INTELAIATA LEGNO

wood door in frame / porte en bois fixée sur le châssis

Porta scorrevole con anta in legno, singola o doppia, e telaio in alluminio estruso. Guida di scorrimento integrata con il profilo fermavetro e fermo ammortizzato in chiusura e apertura. Maniglioni verticali con e senza serratura.

Sliding door with single or double wood panel and extruded aluminium frame. Built-in sliding guide with glazing bead profile and cushioned stop when opening and closing. Vertical handles with and without lock.

Porte coulissante en bois, à simple ou double vitrage et châssis en aluminium extrudé. Rail de guidage intégré avec le profil parcloise et arrêteur tampon en fermeture et ouverture. Grosses poignées verticales avec et sans serrure.

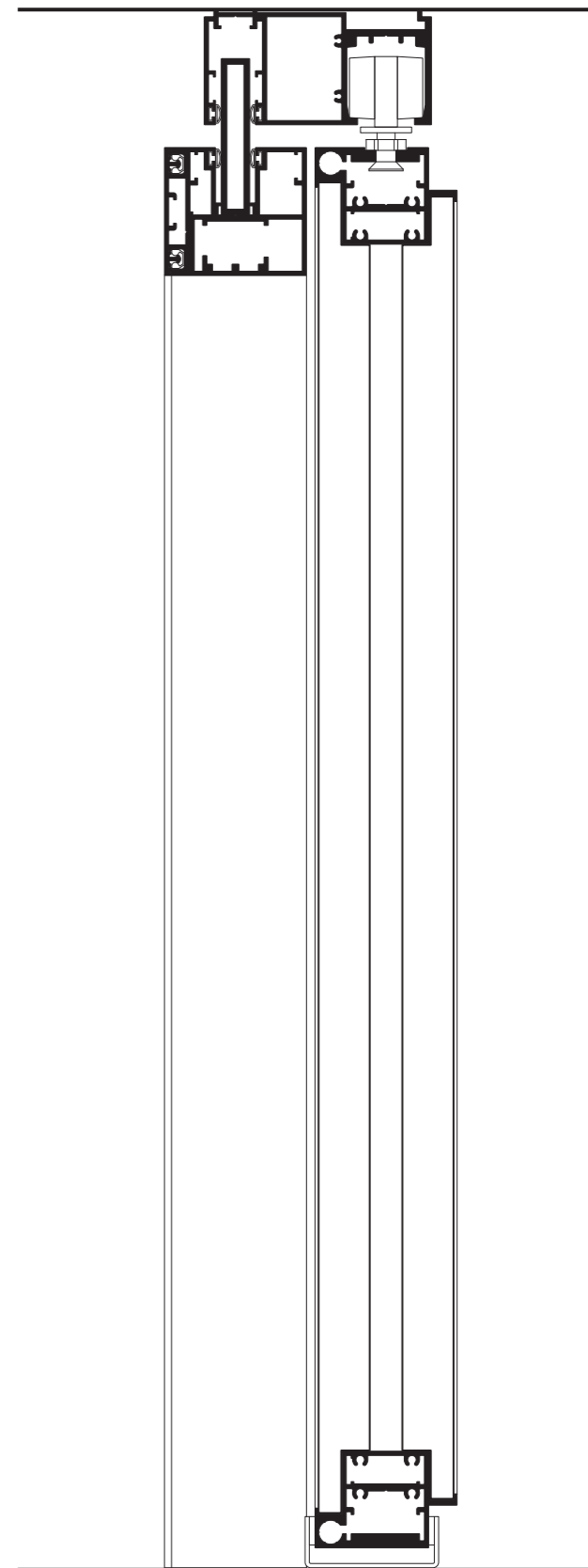

FINITURE
finishes / finitions

F | **ALLUMINIO**
aluminium / aluminium

F | **VETRI**
glass / vitre

F | **LEGNI**
woods / bois

F | **3D FOIL**

F **ALLUMINIO**
aluminium / aluminium



Ossidato argento opaco **FA01**
oxidized matte silver / argent mat



Elettrocolore nero opaco **FA02**
electro colour matte black / elettro couleur noir mat



Silver light lucido **FA50**
light polished stainless / acier inox lucide

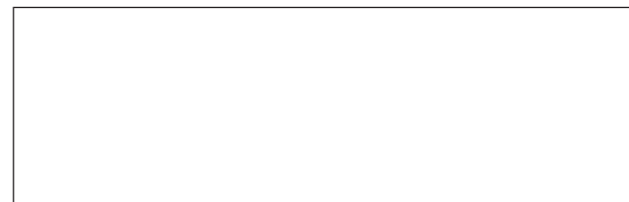

Verniciatura a campione **RAL**
costum paint / coloration à la demande

F **VETRI**
glass / vitre

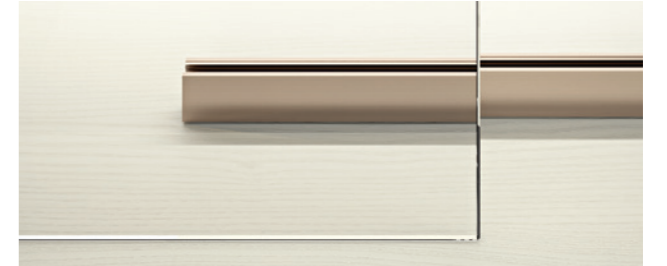

Extrachiaro **FV01**
extra clear / extra-clair



Trasparente **FV02**
transparent / transparent



Satinato **FV03**
satined / satiné



Stop-sol bronzo **FV04**
stop-sol bronze / stop-sol bronzé

F **LEGNI**
 woods / bois
 melaminici / melamine



Pioppo Moro **63**
 Dark Poplar | Peuplier Brun



Pioppo Light **64**
 Light Poplar | Peuplier Clair



Muschio **20**
 moss green / vert mousse



Rovere **03**
 oak / chêne

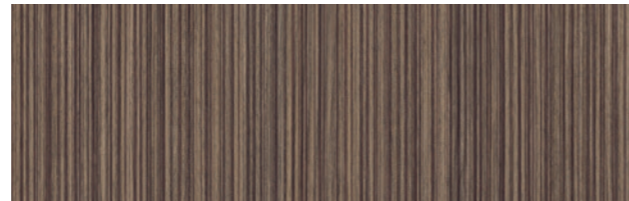

Noce Moderno **13**
 modern walnut / noyer moderne

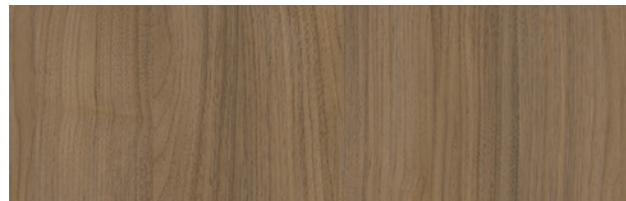

Noce Classico **07**
 classic walnut / noyer classique

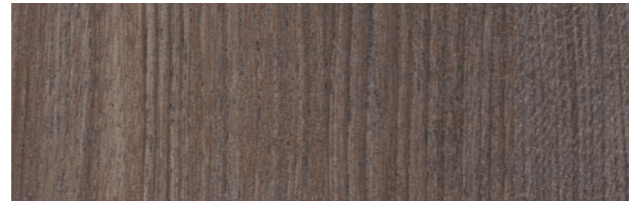

Rovere Naturale **09**
 natural oak / chêne naturel



Stone Grey **44**
 stone grey / stone grey

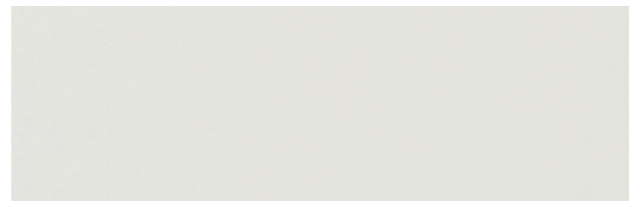

Bianco **68**
 white / blanc

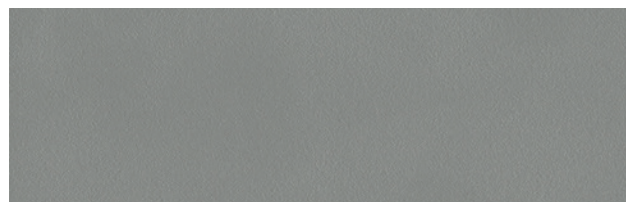

Grigio **38**
 grey / gris



Stone Grey **44**
 stone gray / stone grey

F | **LEGNI**
woods / bois
3D FOIL



Olmo Grey **12**
grey elm / orme grey



Noce Pacific **37**
pacific walnut / noyer pacific



Teak Samoa **67**
samoa teak / teak samoa

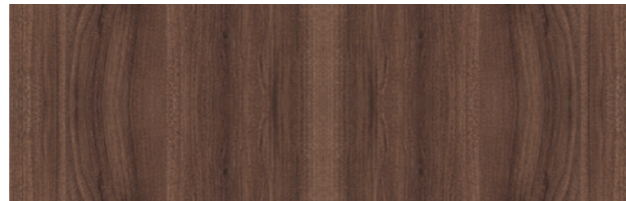

Noce bali **30**
bali walnut / noyer bali

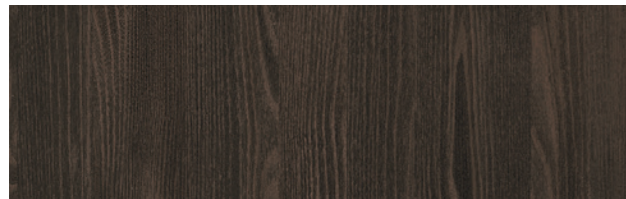

Frassino brown **52**
brown ash / frene brown

ACCESSORI
accessories / accessoire

A | 1

A | 1

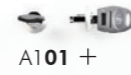

A101 +



A102 +



A103 + O X □



A104 X □



A105 Δ



A106 Δ

+ **CONTENITORE**
cabinet / conteneur

△ **ANTA IN VETRO**
glass door / porte en verre

○ **ANTA INTELAIATA MONOVETRO**
single panel door in the frame / porte mono-vitre fixée sur le châssis

X **ANTA INTELAIATA DOPPIO VETRO**
double panel door in the frame / porte double-vitrage fixée sur le châssis

□ **ANTA INTELAIATA LEGNO**
wood door in frame / porte en bois fixée sur le châssis



A107 O X □



A109 Δ O



A111 Δ



A108 O X □



A110 Δ O



A112 Δ

H = 300mm

H = 1000mm